

UNIVER pneumatic cylinders which comply with ISO 6431 and VDMA 24562 standards, take advantage of the improvements arising from the research of the last years; infact, they can fully satisfy the most demanding users. The operation with non-lubricated air is worth mentioning, since it allows their use in many industrial sectors while protecting the environment. The strong construction and the selected components contribute to giving them excellent operating features and a very long life.

### TECHNICAL CHARACTERISTICS

Working pressure: 1,5 ÷ 10 bar  
 Ambient temperature: -20 ÷ 80°C.  
 Fluid: filtered air, with or without lubrication.  
 Barrel: internal/external anodised aluminium and piston rod in chromium-plated steel standard.  
 Bores: series KD 32 ÷ 125 aluminium barrel with profiles for flush-mounted sensors, magnetic version standard.  
 series K 32 ÷ 200 aluminium barrel;  
 Ø160 ÷ 200 mm with round aluminium barrel and steel tie-rods, magnetic version upon request.

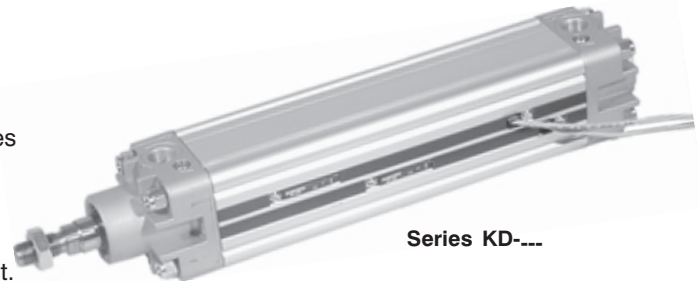

Series KD----

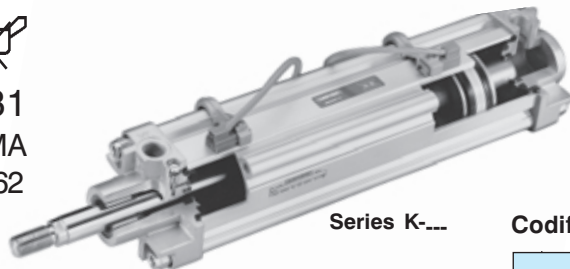

Series K----



Flush-mounted magnetic sensors DF---- series for KD series.  
 Wire protection strap magnetic sensor for KD series part no. DHF-002100.  
 Magnetic sensor DH---- Series for K series.  
 (Section Accessories page 2)  
 Accessories as from page 15.

**Upon request**

- Magnetic rings in plastroferrite
- Locking units Ø 32 ÷ 125 mm to be coupled **only** with chromium-plated steel rod series KD2... (section High-Tech page 3)
- Slide units Ø 32 ÷ 100 mm (section High-Tech page 36)
- Cylinders with rigid bushing, in tandem, multiple position and opposed version (page 13).

**Construction details**

Clean line barrel produced from extruded aluminium alloy with ribbed "anti-twist" design. Internal and external surfaces anodised to 15 micron.

Die-cast end-caps in aluminium alloy mounted on the barrel holes with self-tapping steel screws.

Pneumatic adjustable cushions provide efficient piston deceleration.

Synthetic rubber shock absorbers avoid mechanical stress and reduce machinery noise (lower than 50 dB).

Die-cast aluminum alloy piston and guide shoe in acetalic resin with a permanent plastroferrite magnetic ring (upon request for the magnetic version).

The piston and cushion seals are made of a wear-resistant nitrile rubber compound suitable for applications with or without lubrication. The double lip seal design automatically self-compensates against wear.

Hardened stainless steel rod (K-KD...100 series) or chromium-plated (K-KD...200 series) with 2 micron Ra.; supplied with nut.

UNIVER original self-lubricating and self-aligning piston rod bush. For special applications, rigid bushings are supplied upon request.

Cylinders Ø 125-160-200 with rigid piston rod bushing standard supplied.

**Codification key**

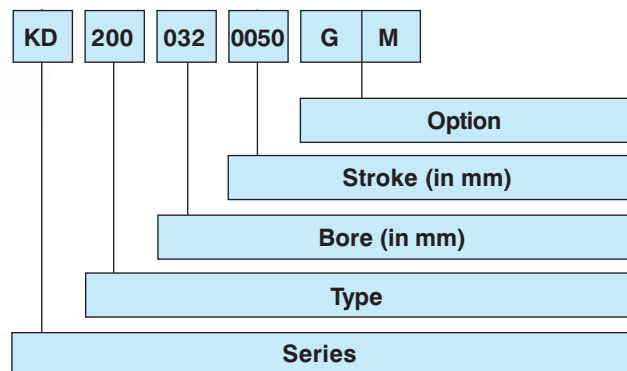

**SERIES**

**KD** = Ø 32÷125 mm magnetic version standard.  
**K** = Ø 32÷200 mm magnetic version upon request.

**TYPE**

- 1.0.0 D.A. Stainless steel rod
- 1.0.1 D.A. Stainless steel through rod
- 1.6.0 S.A. Stainless steel retracted rod, max. stroke 50 mm
- 1.7.0 S.A. Stainless steel extended rod, max. stroke 50 mm
- 2.0.0 D.A. Chromium-plated rod
- 2.0.1 D.A. Chromium-plated through rod
- 2.6.0 S.A. Chromium-plated retracted rod, max stroke 50 mm
- 2.7.0 S.A. Chromium-plated extended rod, max stroke 50 mm

**BORE**

Ø 032 - 040 - 050 - 063 - 080 - 0100 - 0125 - 0160 - 0200

**STROKE**

Standard strokes in mm: 0025 - 0050 - 0075 - 0080 - 0100 - 0125 - 0150 - 0160 - 0175 - 0200 - 0250 - 0300 - 0320 - 0350 - 0400 - 0450 - 0500 - 0600 - 0700 - 0800 - 0900 - 1000

**OPTION**

- F** = For use with locking unit with "reduced dimensions"
- G** = For use with locking unit with ISO dimensions
- M** = Magnetic version

Cyl. Ø	Resultant forces in N at different working pressures (bar). 1 bar = 0,1 MPa							Cushion	
	Working surface area (mm <sup>2</sup> )	Working pressure (bar)					length (mm)	Max kinetic energy absorption (J)	
		2	4	6	8	10			
32	thrust traction	804 691	161 138	322 276	482 414	643 553	804 691	18	1,8
40	thrust traction	1256 1056	251 211	502 422	754 633	1005 844	1256 1055	24	2,5
50	thrust traction	1962 1649	393 330	785 660	1178 990	1570 1320	1963 1650	24	4,5
63	thrust traction	3116 2802	623 560	1246 1120	1869 1680	2493 2240	3116 2800	30	8
80	thrust traction	5024 4533	1005 907	2010 1814	3014 2722	4019 3629	5024 4536	30	12
100	thrust traction	7850 7359	1570 1472	3140 2944	4710 4416	6280 5888	7850 7360	35	21
125	thrust traction	12266 11462	2453 2294	4906 4588	7359 6882	9812 9176	12266 11470	35	36
160	thrust traction	20096 18840	4019 3770	8038 7540	12058 11310	16077 15080	20096 18850	45	52
200	thrust traction	31400 30144	6280 6029	12560 12058	18840 18086	25120 24115	31400 30144	45	95

For through rod cylinders the theoretical force is equal in both directions and its value is the one given "in traction" as per table.  
The values given are theoretical and in practice must take account of weight and friction of the moving element and may be reduced by (~10%)

## Single-acting cylinders

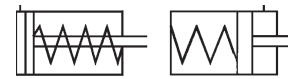

## Theoretical forces (N) for return stroke

Cyl. Ø	F <sub>1</sub> (N) Max spring force at 0 stroke	F <sub>2</sub> (N) Minimum spring force at stroke 50
32	52	28
40	70	42,5
50	98	48
63	98	48
80	140	80
100	140	80
125	235	175

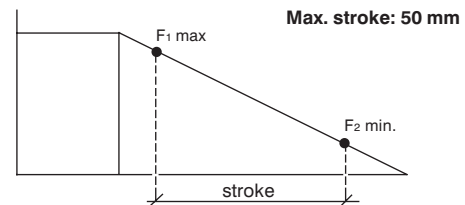

## Graph showing theoretical forces/pressures and acceptable strokes depending on maximum peak load

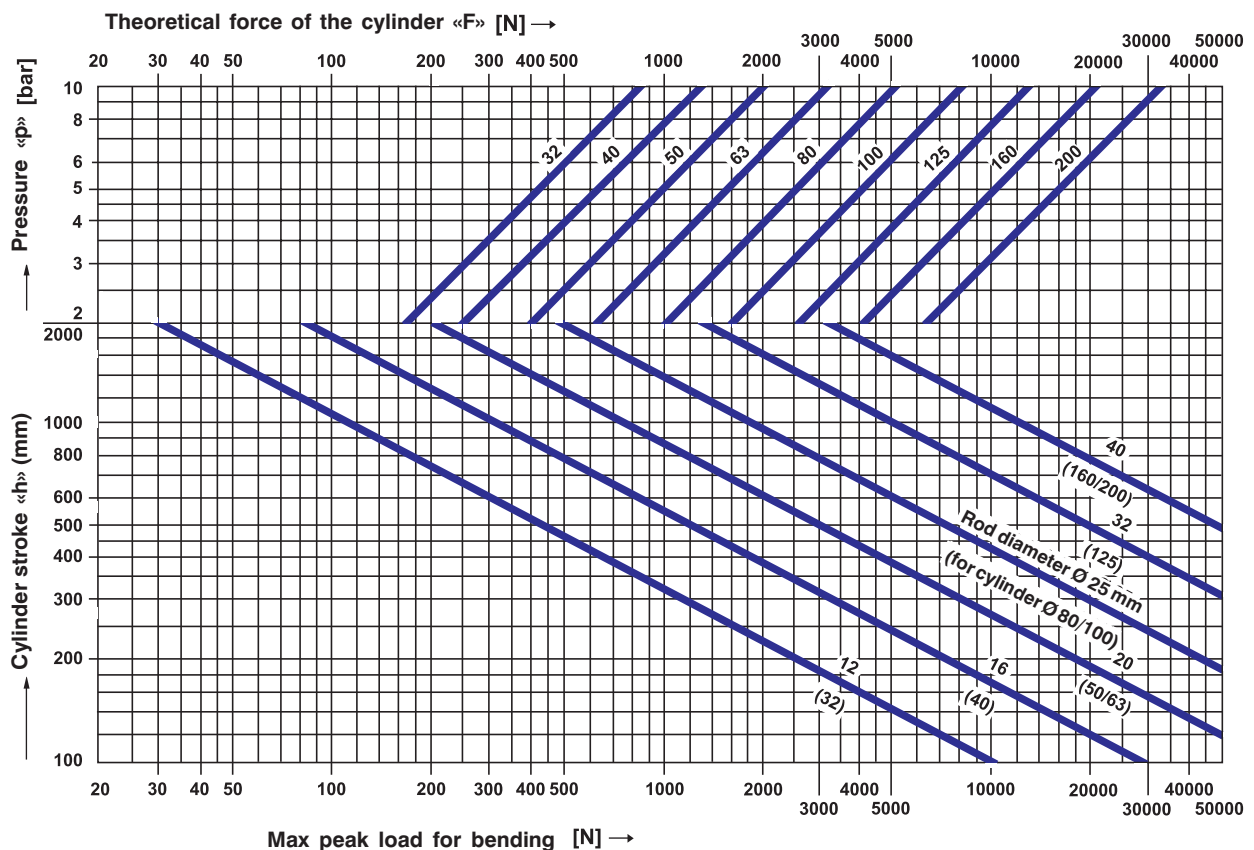



Cylinder with pneumatic cushioning Ø 32 ÷ 200

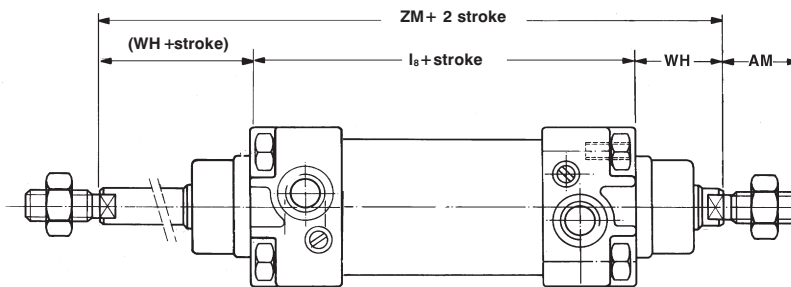
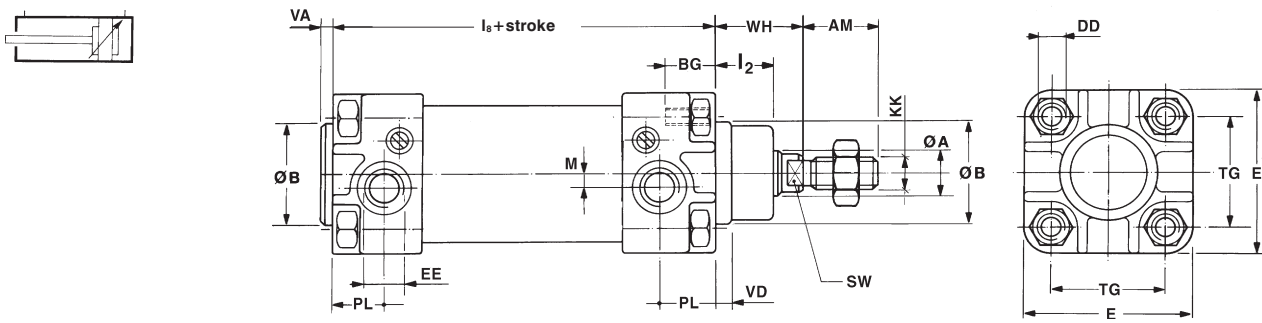

Stroke tolerances

Cyl. Ø	Stroke (m)	
32	up to 500	+2 0
	from 501 to 1.250	+3,2 0
63	up to 500	+2,5 0
	from 501 to 1.250	+4 0
125	up to 500	+4 0
	from 501 to 1.250	+5 0

Cyl. Ø	A	AM (Note 1)		B e11	BG	DD	E	EE (Note 2)		I <sub>2</sub>	I <sub>8</sub>		KK (Note 1)		M	PL	SW	TG		VD	VA	WH	ZM
		Nom.	Toll.					Nom.	Toll.		Nom.	Toll.											
32	12	22	30	14	M6	48	G 1/8	16	94	±0,4	M10 x 1,25	4,5	15	10	32,5	±0,5	5	3	26	146			
40	16	24	35	14	M6	54	G 1/4	20	105	±0,7	M12 x 1,25	5	18	13	38	±0,5	6	4	30	165			
50	20	32	40	16	M8	67	G 1/4	26	106	±0,7	M16 x 1,5	6	18	17	46,5	±0,6	6	4	37	180			
63	20	32	45	16	M8	78	G 3/8	26	121	±0,8	M16 x 1,5	8	21,5	17	56,5	±0,7	6	4	37	195			
80	25	40	45	16	M10	97	G 3/8	32	128	±0,8	M20 x 1,5	7,5	21,5	22	72	±0,7	8	5	46	220			
100	25	40	55	16	M10	115	G 1/2	35	138	±1	M20 x 1,5	9	21,5	22	89	±0,7	8	6	51	240			
125	32	54	60	20	M12	140	G 1/2	45	160	±1	M27 x 2	11	24,5	27	110	±1,1	10	7	65	290			
160*	40	72	65	25	M16	180	G 3/4	50	180	±1,1	M36 x 2	14	29	36	140	±1,1	10	6	80	340			
200*	40	72	75	25	M16	220	G 3/4	60	180	±1,1	M36 x 2	14	29	36	175	±1,1	12	6	95	370			

NOTE 1: "KK" and "AM" dimensions correspond to ISO 4359 "long" type

■ Dimensions to specifications, upon request

\* Ø 160 and Ø 200 cyl., execution with aluminum tube and steel tie-rods

NOTE 2: "EE" dimensions are in inches and are chosen according to ISO 228/1 standard

K series cylinder mass

Cyl. Ø	Cyl. stroke 0 (kg)	Increm. per mm stroke (g)	Moving element stroke=0 (kg)	Increm. per mm stroke (g)	Cylinder stroke 0 (kg)	Increm. per mm stroke (g)	Moving element stroke=0 (kg)	Increm. per mm stroke (g)
32	0,51	2,35	0,13	0,9	0,64	3,24	0,20	1,8
40	0,77	3,24	0,24	1,6	0,92	4,80	0,37	3,2
50	1,21	4,75	0,43	2,5	1,51	7,22	0,64	5,0
63	1,74	5,78	0,47	2,5	2,03	8,25	0,75	5,0
80	2,74	8,64	0,95	3,9	3,26	12,50	1,37	7,8
100	3,78	10,4	1,18	3,9	4,38	14,30	1,60	7,8
125	6,59	14,8	2,18	6,3	7,80	21,10	3,20	12,6
160	14,60	16,9	4,02	9,9	16,85	26,80	5,94	19,8
200	16,50	18,5	4,78	9,9	19,90	28,40	6,80	19,8

KD series cylinder mass

Cyl. Ø	Cyl. stroke 0 (kg)	Increm. per mm stroke (g)	Moving element stroke=0 (kg)	Increm. per mm stroke (g)	Cylinder stroke 0 (kg)	Increm. per mm stroke (g)	Moving element stroke=0 (kg)	Increm. per mm stroke (g)
32	0,53	2,8	0,13	0,9	0,66	3,7	0,20	1,8
40	0,80	4,0	0,24	1,6	0,95	5,5	0,37	3,2
50	1,27	6,0	0,43	2,5	1,57	8,5	0,64	4,9
63	1,76	6,2	0,47	2,5	2,05	8,7	0,75	4,9
80	2,86	10,8	0,95	3,9	3,38	14,7	1,37	7,7
100	3,95	13,4	1,18	3,9	4,55	17,3	1,60	7,7
125	6,87	18,6	2,18	6,3	8,08	24,9	3,20	12,6



**Tandem cylinder -**

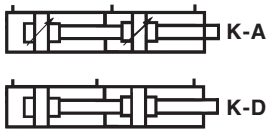

Tandem cylinders are constructed using two pistons coupled together which provide double the force in forward movement compared to the traditional ISO cylinders of the same bore size (refer to tables on page 11).

Cyl. Ø*	EE	L (mm)	S (max)
32	G 1/8	169	3
40	G 1/4	189	5
50	G 3/8	175	4
63	G 3/8	195	7
80	G 1/2	211	6
100	G 1/2	224	9
125	G 1/2	251	9

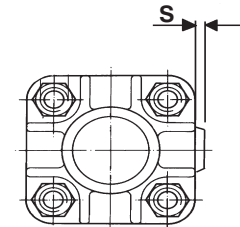
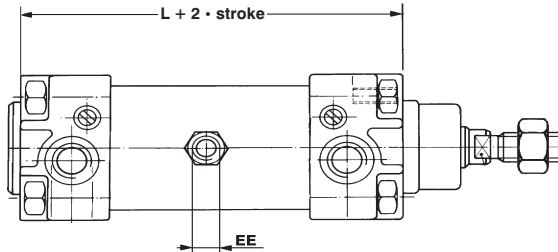

电话: 0592-6054592  
Email: 13779968079@139.com  
厦门昊盛工贸有限公司

**Codification key**

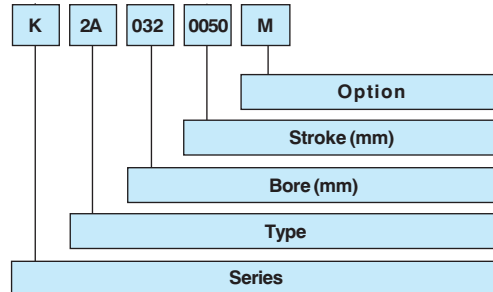

**SERIES**

**K** = pneumatic cylinders ISO 6431 and VDMA 24562 standard  
**KD** = pneumatic cylinders ISO 6431 and VDMA 24562 magnetic version standard

**TYPE**

**Stainless steel rod**  
**1A** double thrust only for forward movement  
**1D** double thrust only for reverse movement  
**Chromium-plated rod**  
**2A** double thrust only for forward movement  
**2D** double thrust only for reverse movement

**OPTION**

**M** = magnetic version upon request for K series

**Two-position tandem cylinder -**

Two-position cylinders with two independent piston-rods which allow to realize a double positioning in which the thrust forces are the same as those of an ISO cylinder of the same bore (see tables on page 11).



Cyl. Ø*	EE	L (mm)	S (max)
32	G 1/8	166	3
40	G 1/4	186	5
50	G 1/4	172	4
63	G 3/8	192	7
80	G 3/8	208	6
100	G 1/2	221	9
125	G 1/2	248	9

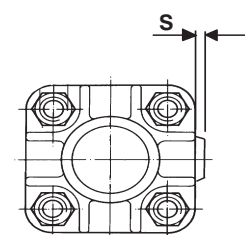
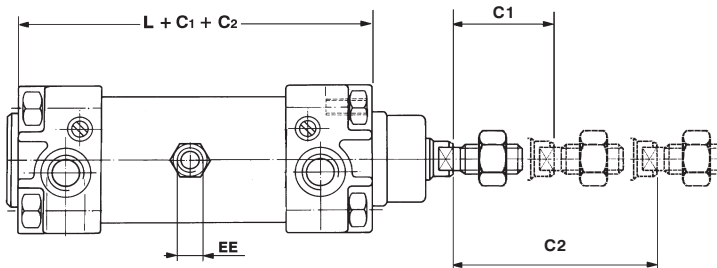

**Codification key**

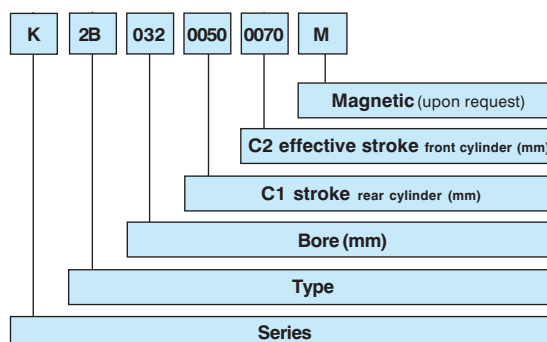

**SERIES**

**K** = pneumatic cylinders ISO 6431 and VDMA 24562 standard  
**KD** = pneumatic cylinders ISO 6431 and VDMA 24562 magnetic version standard

**TYPE**

**1B** double-acting two position tandem cylinder male rod in stainless steel  
**2B** double-acting two position tandem cylinder male rod in chromium-plated steel

**OPTION**

**M** = magnetic version upon request for K series

### Opposed cylinder -

K-C

Type of cylinder characterized by the coupling of two and whose piston rods move in opposite directions. The values of the thrust force are the same as those of the traditional cylinders (see tables on page 11).



Cyl. Ø*	L
32	194
40	220
50	222
63	252
80	266
100	288
125	334
160	378
200	382

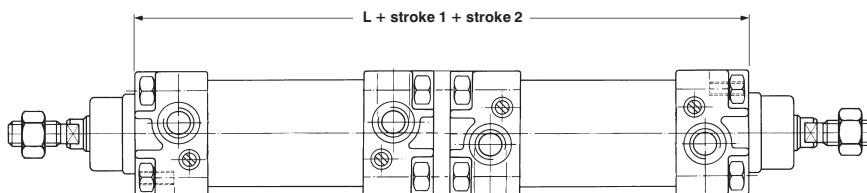

#### Codification key

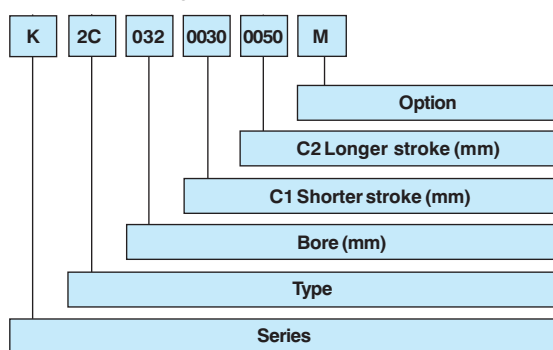

#### SERIES

- K** = pneumatic cylinder ISO 6431 and VDMA 24562 standard
- KD** = pneumatic cylinder ISO 6431 and VDMA 24562 magnetic version standard

#### TYPE

- 1C** Double-acting opposed cylinder male rod in stainless steel
- 2C** Double-acting opposed cylinder male rod in chromium-plated steel

#### OPTION

- M** = magnetic version upon request for K series

### Pneumatic cylinders - with long cushioning

Type of cylinders Ø 40-50-63 mm deriving from K and KD series supplied with long internal cushionings to be used for opening and closing bulkheads or in those sectors in which is needed, at the end of the stroke, a gradual and constant deceleration with a higher control than that of a traditional cylinder. Dimensions (except those indicated) and accessories don't change.

Ø	Cushioning length			
	75	100	150	200
	<b>L8 + Stroke</b>			
<b>40</b>	182	232	332	432
<b>50</b>	178	228	328	428
<b>63</b>	185	235	335	435
<b>80</b>	190	240	340	440

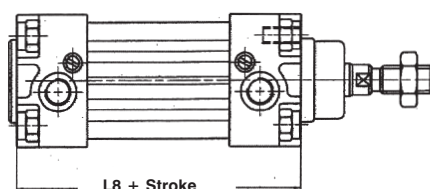

#### Codification key

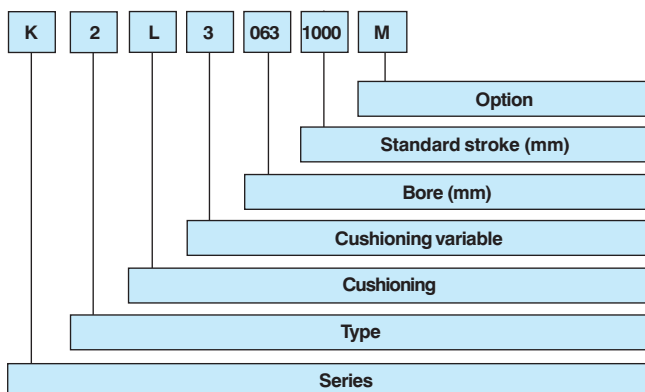

#### TYPE

- 1** = double-acting stainless steel rod
- 2** = double-acting chromium-plated steel rod

#### CUSHIONING

**L** = Long

#### CUSHIONING VARIABLE

- 1** = 075 mm
- 2** = 100 mm
- 3** = 150 mm
- 4** = 200 mm

#### BORE

040-050-063-080 mm

#### STROKE

A minimum stroke three times the length of the cushioning indicated in the table is recommended.

#### OPTION

- M** = magnetic version upon request for K series

#### SERIES

- K** = pneumatic cylinders ISO 6431 and VDMA 24562 standard
- KD** = pneumatic cylinders ISO 6431 and VDMA 24562 magnetic version standard



Hinge (female) in die-cast aluminium ISO MP2 with pin, MP4 (male) without pin

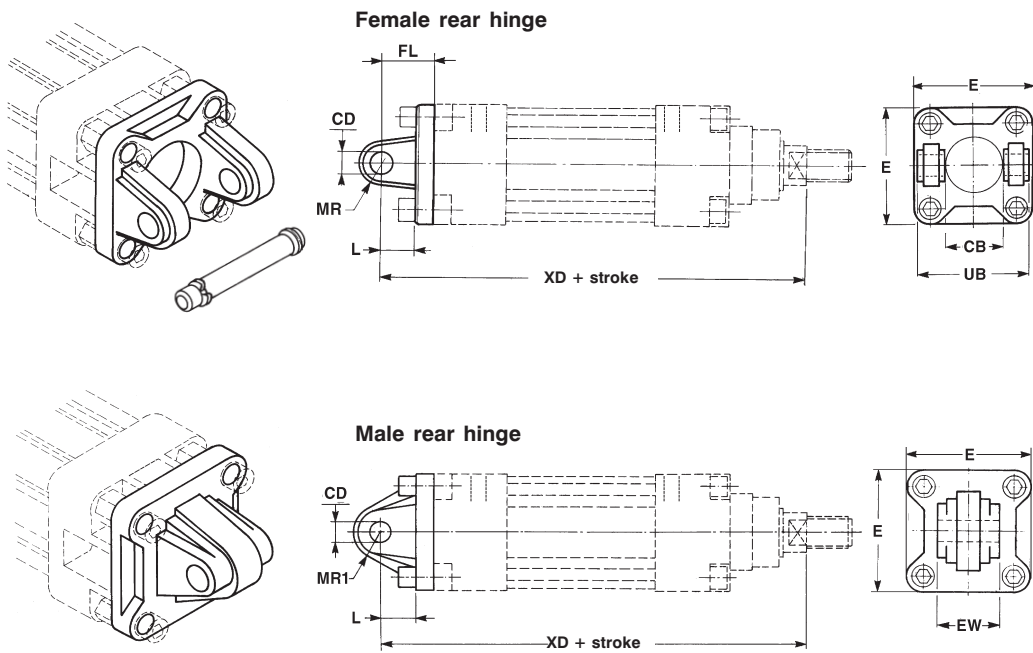

Cyl. Ø	Part number	Mass kg
32	KF-10032A	0,06
40	KF-10040A	0,08
50	KF-10050A	0,15
63	KF-10063A	0,25
80	KF-10080A	0,36
100	KF-10100A	0,6
125	KF-10125A	1,8
160	KF-10160A	2,4
200	KF-10200A	3,5

Cyl. Ø	Part number	Mass kg
32	KF-11032	0,08
40	KF-11040	0,1
50	KF-11050	0,17
63	KF-11063	0,25
80	KF-11080	0,42
100	KF-11100	0,66
125	KF-11125	1,5
160	KF-11160	2,3
200	KF-11200	3,5

Pin see page 18-I.

Fixing screws see page 18



6431  
VDMA  
24562

Front/rear flange in zinc-plated steel, ISO MF1-MF2 (VDMA standard upon request)

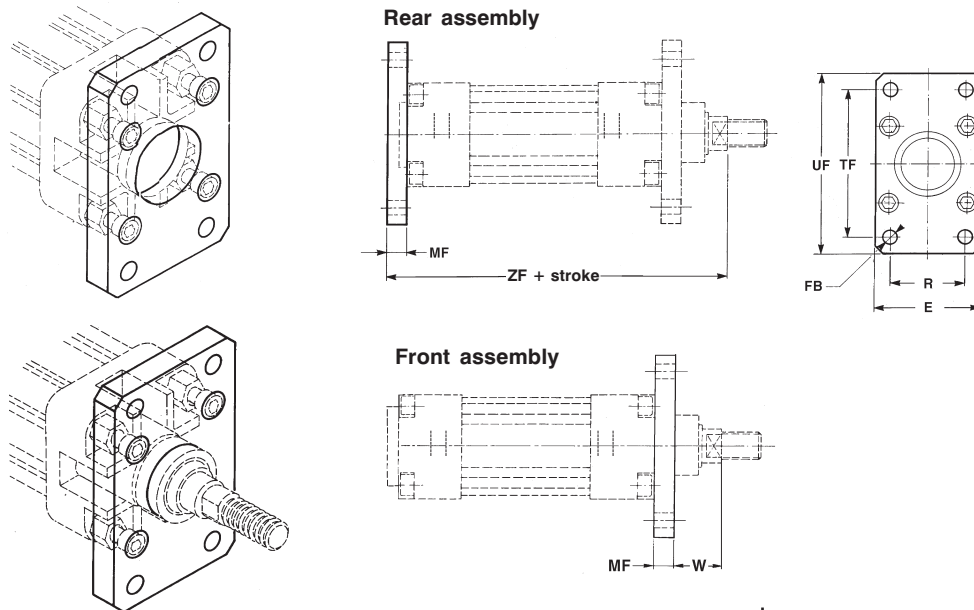

Cyl. Ø	Part number	Mass kg
32	KF-12032	0,2
40	KF-12040	0,25
50	KF-12050	0,5
63	KF-12063	0,65
80	KF-12080	1,5
100	KF-12100	2,2
125	KF-12125	4,1
160	KF-12160	7
200	KF-12200	12,4

Dimensions of ISO MP2 - MP4 hinge

Dimensions of ISO MF1-MF2 flange

Cyl. Ø	CB H14	CD H9	E	EW		FL ±0,2	L (min)	MR (max)	MR1*	UB h14	XD		E	FB H13	MF ±0,2	R JS14	TF JS14	UF	W		ZF	
				Nom.	Tol.						Nom.	Tol.							Nom.	Tol.	Nom.	Tol.
40	28	12	54	28	-0,2	25	15	13	18*	52	160	±1,25	52	9	10	36	72	90	20	±1,6	145	±1,25
50	32	12	65	32	-0,6	32	20	17	23*	70	190	±1,6	75	9	12	50	100	120	25	±2	170	±1,6
63	40	16	75	40	-0,5	41	25	21	29,5*	110	230	±1,6	115	14	16	75	150	170	35	±2	205	±1,6
80	50	16	95	50	-1,2	55	35	31	30*	170	315	±2	180	18	20	115	230	260	60	±2,5	280	±2
100	60	20	115	60	-1,2	60	35	31	30*	170	335	±2	220	22	25	135	270	300	70	±2,5	300	±2

\* Non-standard dimension



Angle bracket in zinc-plated steel ISO MS1

Fixing screws see page 18

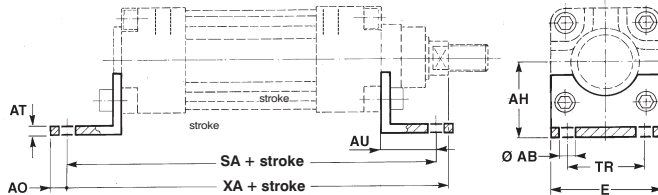
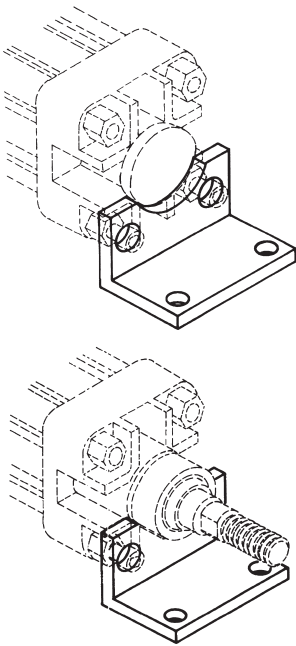

Cyl. Ø	Part number	Mass kg
32	KF-13032	0,2
40	KF-13040	0,25
50	KF-13050	0,5
63	KF-13063	0,65
80	KF-13080	1,5
100	KF-13100	2,2
125	KF-13125	4,1
160	KF-13160	7
200	KF-13200	12,4



6431  
VDMA  
24562

Intermediate hinge ISO MT4 with fixing grub screws only for "K" cylinders (bores 160/200 assembled on tie-rods)

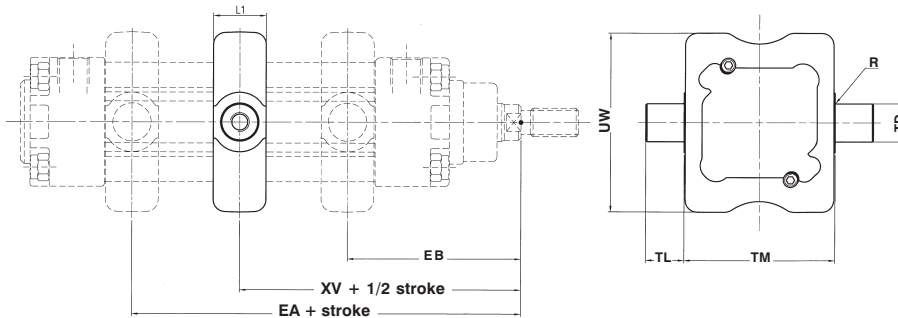

Cyl. Ø	Part number	Mass kg
32	KF-14032	0,13
40	KF-14040	0,24
50	KF-14050	0,32
63	KF-14063	0,61
80	KF-14080	0,93
100	KF-14100	1,6
125	KF-14125	2,2
160	KF-14160	4,3
200	KF-14200	7,5

NOTE: the dimension XV + 1/2 stroke indicates the position of the hinge between the end-caps of the cylinder.

Dimensions of ISO MS1 angle bracket

Dimensions of ISO MT4 hinge for K series

Cyl. Ø	AB H13	AH JS15	AO	AT	AU ±0,2	E	SA		TR JS14	XA		EA (max)	EB (min)	I1 (max)	R (max)	TD e9	TL h14	TM h14	UW (max)	XV	
							Nom.	Tol.		Nom.	Tol.									Nom.	Tol.
							32	7		32	6									4	24
40	9*	36	8	4	28	52	161	±1,25	36	163	±1,25	94	71	20	1,5	16	16	63	59	82,5	±2
50	9*	45	10	5	32	64	170	±1,25	45	175	±1,25	102	78	20	1,6	16	16	75	71	90	±2
63	9*	50	12	5	32	74	185	±1,6	50	190	±1,6	108	87	26	1,6	20	20	90	84	97,5	±2
80	12	63	15	6	41	94	210	±1,6	63	215	±1,6	124	96	26	1,6	20	20	110	105	110	±2
100	14*	71	20	6	41	114	220	±1,6	75	230	±1,6	132	108	32	2	25	25	132	129	120	±2
125	16*	90	15	8	45	140	250	±2	90	270	±2	165	125	33	2	25	25	160	154	145	±2,5
160	18*	115	20	10	60	180	300	±2	115	320	±2	190	150	40	2,5	32	32	200	190	170	±2,5
200	22*	135	30	10	70	220	320	±2	135	345	±2	205	165	40	2,5	32	32	250	240	185	±2,5

\* Non-standard dimension

**Intermediate hinge ISO MT4  
with grub screws for cylinders KD series**

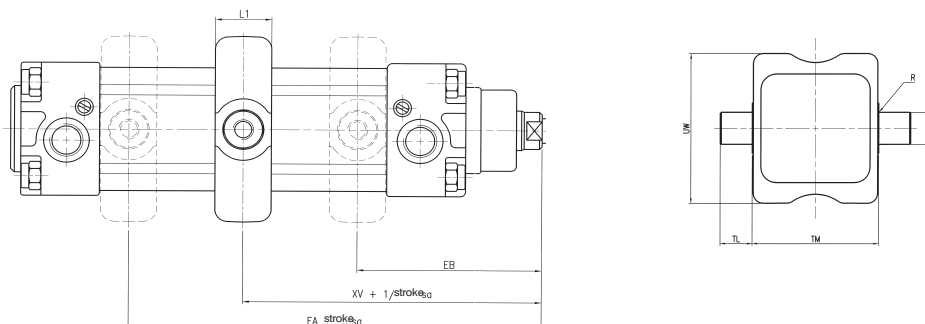

**Dimensions ISO MT4 hinge for KD Series**

Cyl. Ø	EA (max)	EB (min)	I1 (max)	R (max)	TD (e9)	TL (h14)	TM (h14)	UW (max)	XV	
									Nom.	Tol.
32	82	64	22	0,5	12	12	50	65	73	±2
40	93	72	22	0,5	16	16	63	75	82,5	±2
50	101	79	22	1	16	16	75	95	90	±2
63	107	88	28	1	20	20	90	105	97,5	±2
80	123	97	28	1	20	20	110	130	110	±2
100	131	109	34	1	25	25	132	145	120	±2
125	164	126	34	1,5	25	25	160	175	145	±2,5

Cyl. Ø	Part number	Mass Kg
32	KDF-14032	0,12
40	KDF-14040	0,24
50	KDF-14050	0,32
63	KDF-14063	0,47
80	KDF-14080	0,80
100	KDF-14100	1,50
125	KDF-14125	1,92

Min. stroke of the cylinder: 10 mm  
 XV+1/2 stroke: hinge between cylinder end-caps.

**Articulated rear hinge in die-cast aluminum**

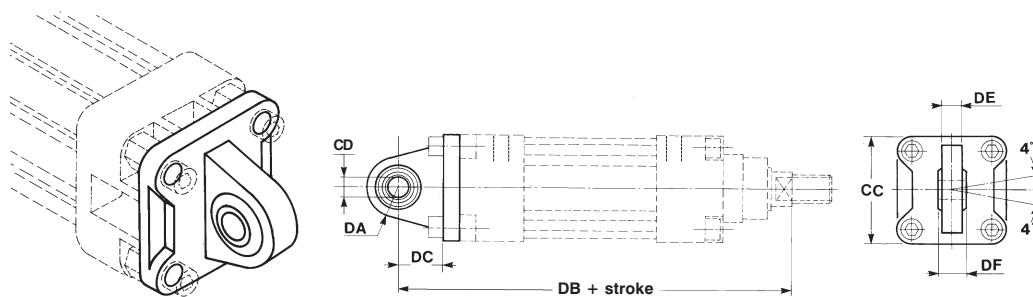

Cyl. Ø	Part number	Mass kg
32	KF-11032S	0,1
40	KF-11040S	0,2
50	KF-11050S	0,3
63	KF-11063S	0,35
80	KF-11080S	1,6
100	KF-11100S	0,7

**Counter-hinge 90° in die-cast aluminium**

Fixing screws see page 18

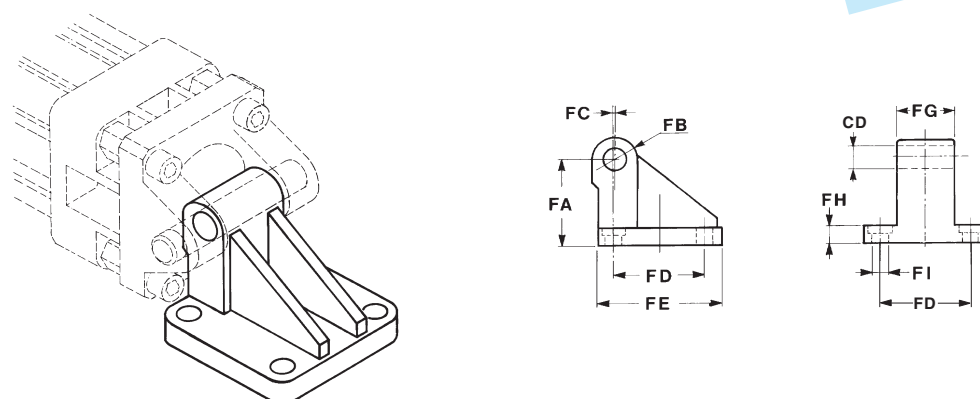

Cyl. Ø	Part number	Mass kg
32	KF-19032	0,09
40	KF-19040	0,12
50	KF-19050	0,20
63	KF-19063	0,32
80	KF-19080	0,58
100	KF-19100	0,91





Pin in zinc-plated steel with 2 circlips

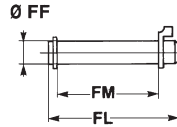
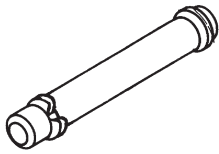

Cyl. Ø	Part number	Mass kg
32	KF-18032	0,03
40	KF-18040	0,05
50	KF-18050	0,05
63	KF-18063	0,12
80	KF-18080	0,15
100	KF-18100	0,29
125*	KF-18125	1,53
160*-200*	KF-18160	1

\* Pin for part nos. KF10...

Dimension of articulated male hinge

Dimension of 90° counter-hinge

Dimension of pin

Cyl. Ø	Dimension of articulated male hinge							Dimension of 90° counter-hinge									Dimension of pin		
	CC	CD H9	DA	DB	DC	DE	DF	CD H9	FA	FB	FC	FD	FE	FG	FH	FI	FF f8	FL	FM
32	48	10	15	142	14	10,5	14	10	32	10	1,2	32,5	49	26	10	6,4	10	53	46
40	54	12	18	160	16,5	12	16	12	36	12	2,6	38	55	28	10	6,4	12	61,3	53
50	65	12	20	170	17,5	12	16	12	45	12	0,3	46,5	67	32	12	8,4	12	69	61
63	75	16	21	190	21,5	15	21	16	50	16	3,3	56,5	73	40	12	8,4	16	80,5	71
80	95	16	27	210	24	15	21	16	63	16	1,0	72	97	50	14	10,5	16	100,5	91
100	115	20	29,5	230	28	18	25	20	73	20	2,5	89	115	60	16	10,5	20	122,5	111
125																	25	140	131
160																	30	205	171
200																	30	205	171

Piston rod locknut (zinc-plated steel)

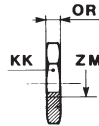
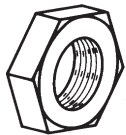

Cyl. Ø	ZM	KK	OR	Part number
32	M10 x 1,25	17	6	KF - 16032
40	M12 x 1,25	19	7	KF - 16040
50 ÷ 63	M16 x 1,5	24	8	KF - 16050
80 ÷ 100	M20 x 1,5	30	9	KF - 16080
125	M27 x 2	41	12	KF - 16125
160 ÷ 200	M36 x 2	55	14	KF - 16160

Fixing screws for accessories

Cylindrical screw UNI 5931  
Part n. AZ4-VN... suitable for  
mounting elements  
series KF-10.../ KF-11...  
KF-11...S

Cylindrical screw UNI 5931 and  
DIN 7984 Part n. AZ4-VN.../AZ4-  
VPA... suitable for mounting  
elements series KF-19...

Cylindrical screw UNI 5931  
Part n. AZ4-VN... suitable  
for mounting elements  
Series KF-12.../KF-13...

Cyl. Ø	Screw	Part number
32-40	M6 x 18	AZ4-VN0618
50-63	M8 x 22	AZ4-VN0822
80-100	M10 x 25	AZ4-VN1025
125	M12 x 35	AZ4-VN1235

Cyl. Ø	Screw 2 pcs. each type	Part number
32-40	M6 x 14	AZ4-VN0614
	M6 x 18	AZ4-VN0618
50-63	M8 x 16	AZ4-VPA0816
	M8 x 22	AZ4-VPA0822
80-100	M10 x 20	AZ4-VPA1020
	M10 x 25	AZ4-VPA1025

Cyl. Ø	Screw	Part number
32-40	M6 x 14	AZ4-VN0614
50-63	M8 x 16	AZ4-VN0816
80-100	M10 x 20	AZ4-VN1020
125	M12 x 25	AZ4-VN1225



Female fork with clips in zinc-plated steel for piston rod according to ISO 8140 standard with pin

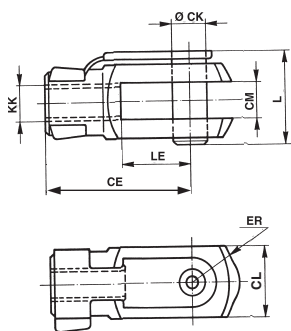

Cyl. Ø	CE	CK	CL	CM B12 B12	ER	KK	L	LE	Mass kg	Part number
	32	40	10	20	10	16	M10 x 1,25	26		
40	48	12	24	12	19	M12 x 1,25	32	24	0,015	KF - 15040
50-63	64	16	32	16	25	M16 x 1,5	40	32	0,34	KF - 15050
80-100	80	20	40	20	32	M20 x 1,5	50	40	0,67	KF - 15080
125	110	30	55	30	45	M27 x 2	65	54	1,79	KF - 15125
160-200	144	35	70	35	57	M36 x 2	81	72	3,87	KF - 15160

Articulated self-lubricating fork in zinc plated steel

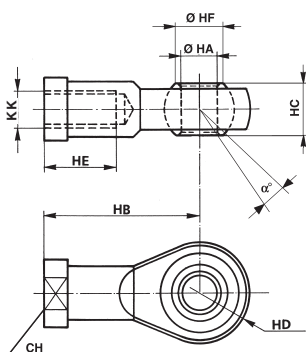

Cyl. Ø	a	CH	KK	HA	HB	HC	HD	HE	HF	Mass kg	Part number
	32	13°	17	M10 x 1,25	10	43	14	14	20		
40	13°	19	M12 x 1,25	12	50	16	16	22	15,4	0,11	KF - 17040
50-63	15°	22	M16 x 1,5	16	64	21	21	28	19,3	0,22	KF - 17050
80-100	14°	30	M20 x 1,5	20	77	25	25	33	24,3	0,4	KF - 17080

Fork with axially mounted articulated pin

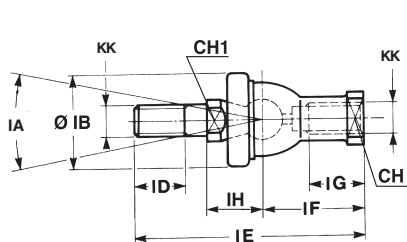

Cyl. Ø	CH	CH1	IA	KK	IH	IB	ID	IE	IF	IG	Mass kg	Part number
					±0,3							
32	17	11	30°	M10 x 1,25	19,5	32	15	74,5	35	18	0,12	KF - 22025
40	19	17	30°	M12 x 1,25	22	36	17	84	40	20	0,185	KF - 22040
50-63	22	19	22°	M16 x 1,5	27,5	47	23	112	50	27	0,36	KF - 22050
80-100	30	24	15°	M20 x 1,5	31,5	58	25	133	63	38	0,57	KF - 22080

Fork with angle-mounted articulated pin

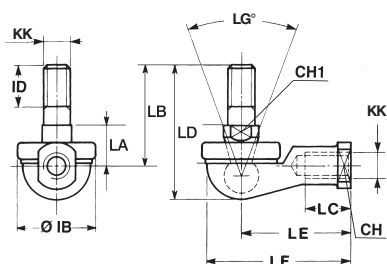

Cyl. Ø	CH	CH1	LG	KK	IB	ID	LA	LB	LC	LD	LE	LF	Mass kg	Part number
							±0,3							
32	17	11	50°	M10 x 1,25	32	15	17	37	21	50,5	43	57	0,11	KF - 23025
40	19	17	50°	M12 x 1,25	36	17	19	42	27	57,5	50	66	0,165	KF - 23040
50-63	22	19	40°	M16 x 1,5	47	23	23,5	60	33	79,5	64	84	0,33	KF - 23050
80-100	30	24	32°	M20 x 1,5	58	25	27	68	40	90	77	99	0,54	KF - 23080



电话: 0592-6054592

Email: 13779968079@139.com